

**LMR PLUS**



**Product Description**

The FD40 LMR Plus Controllers are a full service, part winding reduced voltage controller. A part winding fire pump controller reduces the starting current by up to 40% while maintaining up to 50% motor starting torque. The FD40 is the most economical method of reduced voltage starting, however, requires a special motor wound for part winding starting. The FD40 can be programmed for either fully automatic or semi-automatic operations.

The use of an embedded web page for retrieving diagnostics and history reports, along with USB and Ethernet communication ports for downloading data, make the LMR Plus Series of controllers easy to troubleshoot and maintain. As well, critical information can be easily accessed and used for report generation and analysis, which aids in providing effective, reliable fire protection.

**Product Features**

**Logic Controller Board Communication**

The controller can be ordered with the option to display and output current values and status, on command, from various software protocols through the appropriate port(s).

**Embedded Web Page**

The web page is a multifunction tool that allows the user to view the controller's current status, data values, programmed set points and history. It is accessed using the optional ethernet port.

**Ethernet Port**

An optional Ethernet port can be used for direct connection to a computer for data transfer.

**RS485 Serial Port**

An optional RS485 serial port can be provided for communication to various external software programs.

**USB Port / USB Drive**

The logic controller board is equipped with a USB port that can be used to transfer data to and from a portable USB Drive device (memory stick).

**Buzzer**

A buzzer is mounted on the logic board which will operate if Fail to Start, Hardware Malfunction or any Common Alarm condition exists.

**Power I/O Board Transformers**

Incoming line voltage is run directly to the I/O board from the incoming lines. The I/O board will accept voltage inputs between 100 and 600V.

**Customer Connection Terminals**

Connection terminals for external customer connections, are located at the top of the Power I/O board.



**Output Relays**

Five, 8 Amp, 2 Form - C (DPDT) output relays are provided standard on each power I/O board. They are designated for: Common Alarm, Phase Failure, Phase Reversal, Pump Run and Future #1. Each socket has an LED mounted on the I/O board which indicates each relay's coil status.

**Optional Output Relay Boards**

There is provision to add up to eight additional relay outputs, via optional relay output boards. Each board contains a maximum of 2 additional relays. The Power I/O Board will accept a maximum of 4 optional boards which mount in a snap-on configuration. Each board provides an area for the user to label the terminal number and relay name.

**Drain Valve Solenoid**

All LMR Plus electric controllers are equipped with a drain valve solenoid used for weekly test purposes.

**USB External Drive General**

When using an external USB Drive, the drive should conform to the following specifications:



Min: 128mb  
Max: 2 Gig FAT16 protocol  
USB 1.0 or 2.0

**NEMA 2 Enclosures**

All LMR controllers come standard with NEMA 2 enclosures unless otherwise ordered. Available options include: NEMA 3R, 4, 4X, 12.

**Emergency Start Operator**

A mechanically operated emergency start handle activates the motor contactor independent of any electrical control circuits or pressure switch input.



**Membrane Keypad Door Mount**

The membrane keypad is accessible from the front door of the controller.



**NEMA Rating**

The standard membrane keypad is rated for NEMA 2, 3R, 4, 4X and 12.

**Alarm & Status LED's**

A total of 20, ( 10 Status - 10 Alarm ) LED's provide indication on the membrane keypad.

**Status LED's**

Power On  
Pump Running  
Local Start  
Remote Start  
Deluge Valve  
Emergency Start  
Interlock On  
Low Pressure  
Auto Shutdown Enabled  
Programmable LED # 1

**Alarm LED's**

Phase Reversal  
Phase Failure  
Fail To Start  
Undervoltage  
Overvoltage  
Low Room Temperature  
Locked Rotor Trip  
Low Suction Pressure  
Source 2 Disconnected  
Programmable LED # 2

**Silence Button**

A silence pushbutton on the membrane can be used to silence the buzzer. When an alarm condition exists, the alarm buzzer will sound. If the Silence Alarm button is pressed, the alarm buzzer will turn off. If a subsequent alarm condition occurs after the silence button is pressed, the buzzer will re-sound. Pressing the Silence Alarm button again, will silence the buzzer.

**Motor Test Button**

The motor test button on the membrane can be used to simulate an automatic start.

**Automatic Shutdown Enabled**

When the Automatic Shutdown function is enabled, a Green LED will indicate on the controller membrane.

**Standards & Certification**

The LMR Plus Electric Fire Pump Controllers meet or exceed the requirements of Underwriters Laboratories, Underwriters Laboratories Canada, Factory Mutual, the Canadian Standards Association, New York City building code, CE mark and U.B.C / C.B.C. Seismic requirements, and are built to NFPA 20 standards.



N. Y. C. APPROVED



## Product Features

### Main Display

#### General

The main display will show the current system pressure, time and date, voltage and amps reading for all three phases, the system frequency and any custom messages, alarms or timers.

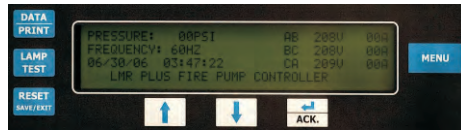

### Programmed Set-Point

The set-point display will show programmed pressure start point, pressure stop point and weekly test timer setting.

### Statistics

The statistics display will allow the user to scroll through all of the measured statistics stored in memory. Refer to LMR Plus operation manual IM05805020K for specific details.

### Diagnostics

The diagnostics display allows the user to scroll through various diagnostic points to assist with troubleshooting the system.

### Message History

The user will be able to scroll through all of the messages stored in the memory of the controller with the most recent message being displayed first.

### PRINT Menu

#### Description

All fault and alarm information is sent to the USB and optional printer on demand, as well as the status of each output. The LMR Plus will store up to 10K events which are time and date stamped. All information can also be retrieved and displayed on the LCD display.

### Saving to USB Drive

The controller will save four separate text files, one CSV file and the embedded webpage to the USB external drive. The files, at maximum size, can be saved multiple times on one 128MB USB drive.

Files to be saved are: Status Report, Diagnostics Report, Statistics Report, Configuration File and Last 10K Messages.

### Print Menu

The optional printer menu is accessed in order to select the desired print function. Functions include: Print Messages, Last XX Messages, Date & Time, Status Report, Diagnostics Report and Statistics Report.

### Custom Messages

When this item is selected, custom messages can be cleared from memory or downloaded from the USB external drive.

### Firmware Update

Firmware revisions are updated from an external USB drive. All previously programmed settings will remain intact when updating is completed. Should there be an update failure, the controller will automatically revert back to the previous version of firmware.

### Embedded Web Page

#### General

The embedded web page is a multifunction tool that will allow the user to view the current status of the controller as well as display all current readings, set points, and history. An external computer can be connected via the optional Ethernet port to access the page. When connected, the controller set points can be programmed via the webpage.



### Multiple Pages

There are 5 viewable pages that show the Main Display, Statistics, Diagnostics, History and Programmed Set Points.

### Pressure Points

The pressure reports recorded in memory can be graphed and/or sorted based on date and time.

### Programmed Set Points

All of the programmed set points and their current status can be viewed via the webpage.

### Custom Messages

Users can create custom messages on a computer and upload to the controller using a USB Drive (memory stick). Up to 10 custom messages of up to 100 characters each, will continuously scroll across the fourth line of the LCD display once triggered.

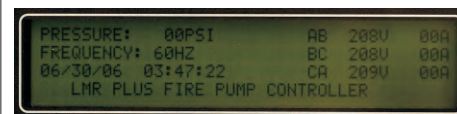

### Trigger Points

The message can be programmed to appear at specific trigger points such as specific date and time, specific number of operations, specific number of hours run or at any individual alarm point.

All of the trigger points can be selected as And/Or values.

### Programming Menu

#### General

The LMR Plus programming menu is divided into 8 different sub-menus. Each sub-menu contains information relative to its particular function. Following is a brief description of each sub-menu.

### Language

The language sub-menu allows the user to select English, French, Spanish or Other languages to be viewed on the LCD Display. Several other languages can be uploaded into the controller. Contact the factory for details.

### Regional

Regional settings include the ability to program the date by adjusting the Month, Day, Year and Day of Week. As well, the Current Time can be adjusted on the 24 hour clock.

### Pressure

A variety of pressure settings can be programmed in the pressure sub-menu. These settings include disabling the pressure transmitter; setting of the start point, stop point, low pressure alarm, high pressure alarm, stop mode, proof pressure switch (for foam units), low suction shutdown (low foam shutdown), pressure deviation and hourly pressure recording. Refer to the LMR Plus operation manual IM05805020K for details.

### Timers

Timers in the LMR Plus that can be programmed include: Run Period Timer (RPT), RPT Start Mode, Acceleration Timer (AT), Weekly Test Timer, Fail to Start Timer (FST) and Sequential Start Timer (SST). Refer to the LMR Plus operation manual IM05805020K for details.

### Alarm Set Points

There are five settable alarm points that can be programmed by the user. They include: Phase Rotation, Over Voltage (OV), Under Voltage (UV), Over Frequency (OF) and Under Frequency (UF). Refer to the LMR Plus operation manual IM05805020K for details.

### Custom Inputs / Outputs

There is provision on the Power I/O Board to accept up to 9 additional inputs and 9 additional outputs. Each of the inputs can be labeled using one of 11 pre-set input descriptions or assigned a custom description that is programmed by the user. The optional outputs can be programmed to indicate up to 25 output conditions. As well, two optional alarm LED's can be programmed for up to 12 alarm conditions.

All optional inputs, outputs and LED's can be linked, as required.

Inputs can be programmed to energize the common alarm output, link to relays and optional LED's and latch until reset by the user.

Outputs can be programmed for fail safe and latch until reset by the user.

Optional inputs and outputs can be programmed with time delay functions.

### System Configuration Menu

The system configuration menu section is password protected and contains settings such as system voltage, frequency, CT ratio etc. Refer to Technical Bulletin PU05805035K/D for details.

### Main Menu Password

A password can be programmed by the user to protect access to the Main Menu. Refer to the LMR Plus Operation Manual IM05805020K for details.

**Pump and Plumbing**

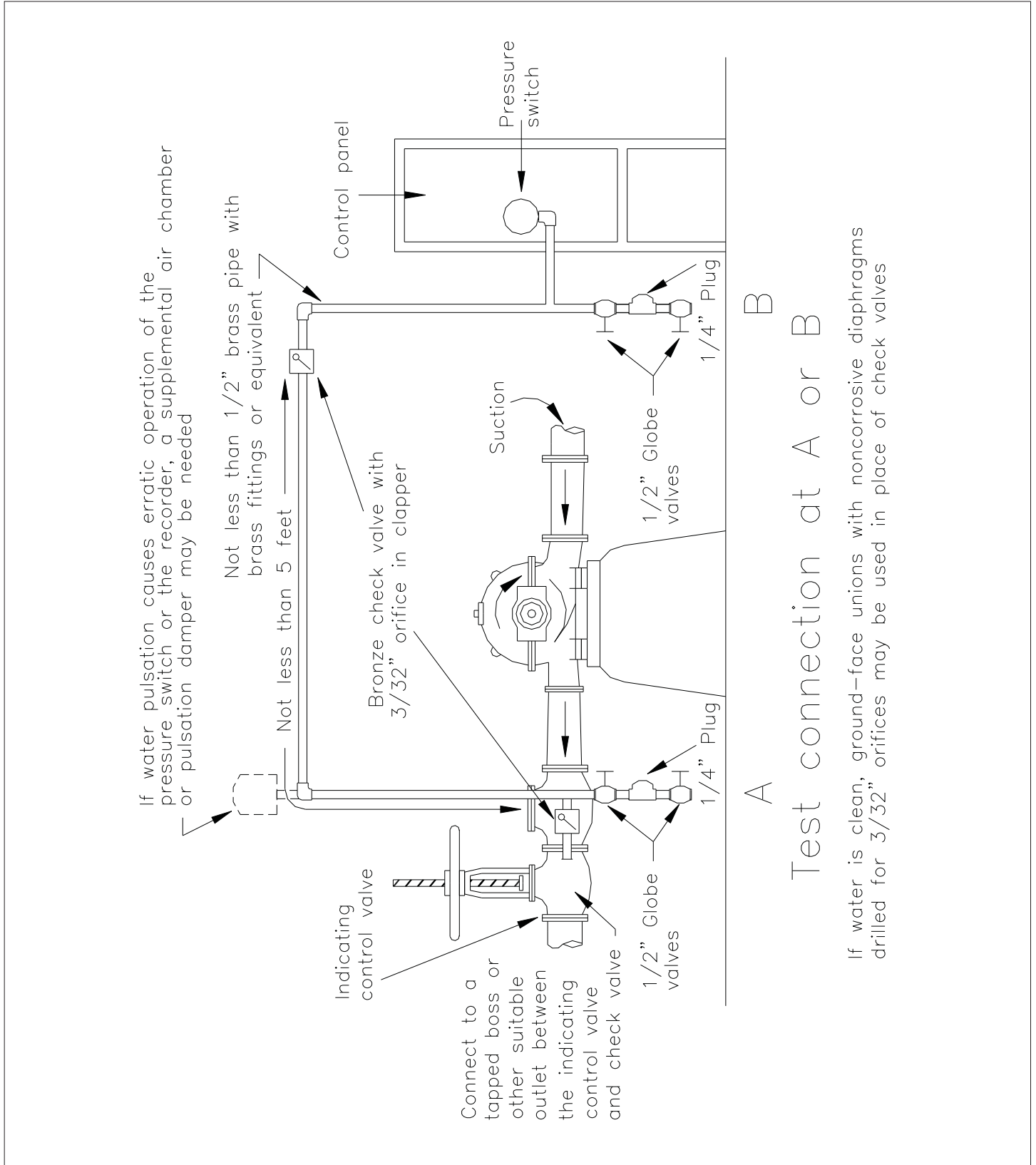

**Main Display**

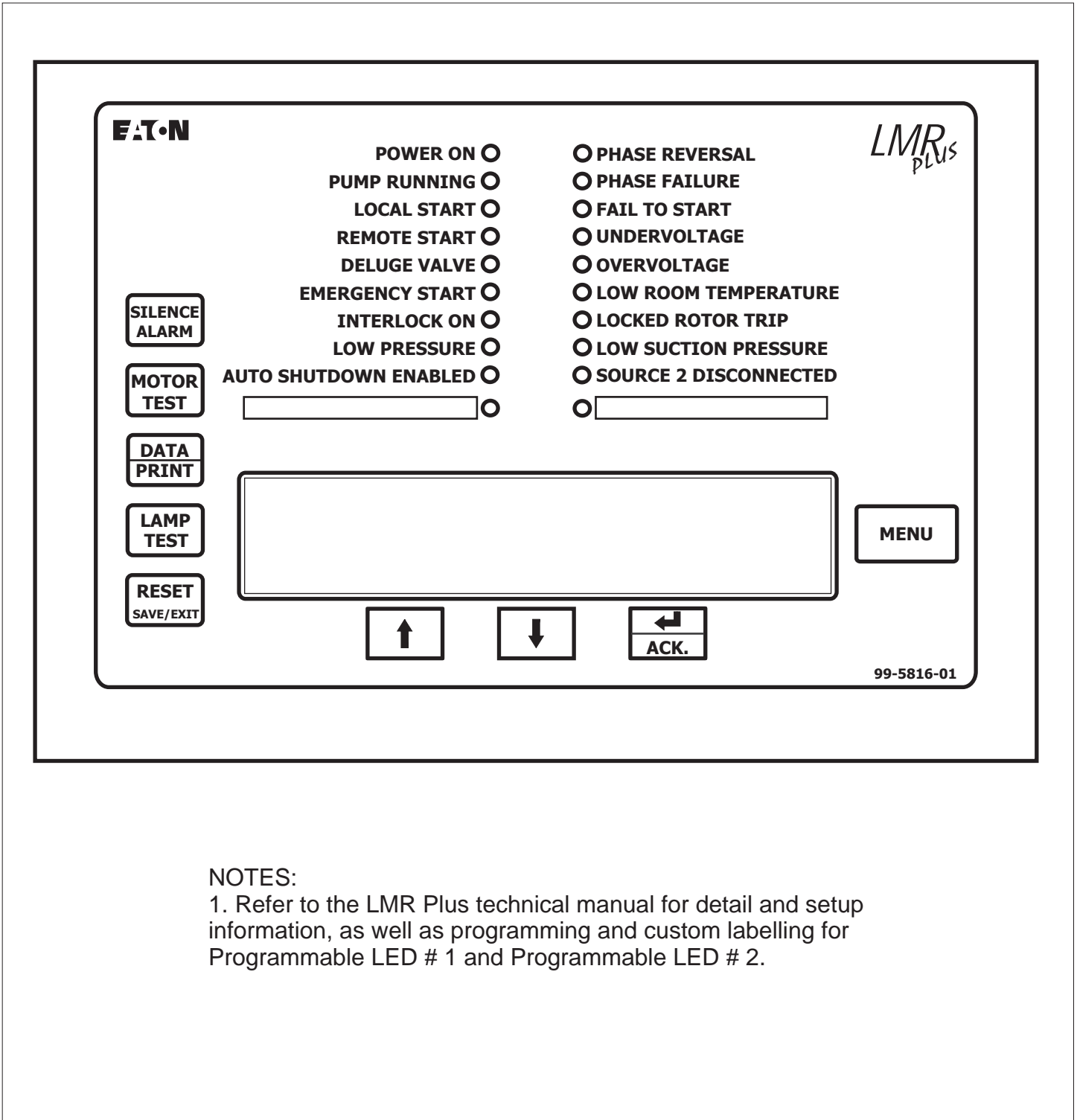

**NOTES:**

1. Refer to the LMR Plus technical manual for detail and setup information, as well as programming and custom labelling for Programmable LED # 1 and Programmable LED # 2.



N. Y. C.  
APPROVED



NOTE: As of January 1, 2009 - All Limited Service Controllers will not carry FM Approval.

**Dimensions**

**Standard Enclosure - Type NEMA 2, 3R, 4, 4X, 12**

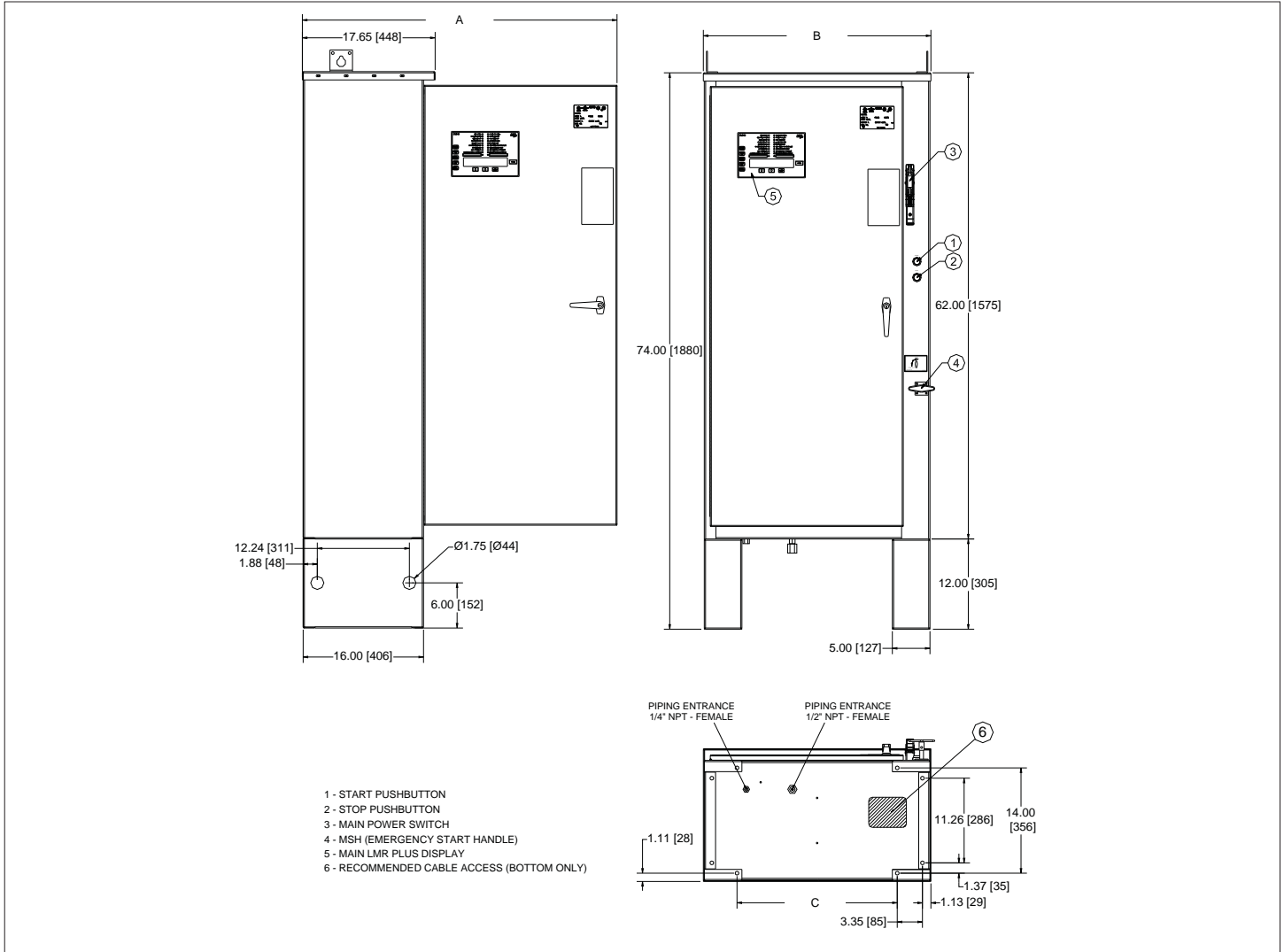

Motor Hp	Line Voltage	Withstand Rating			Approx. Weight Lbs. (Kg)	A	B	C
		Standard	Intermediate	High				
50 - 100	200 - 208V	100,000	Consult Factory	Consult Factory	290 (131)	41.83 (1062)	30.25 (768)	21.30 (541)
60 - 125	220 - 240V							
100 - 200	* 380 - 415V							
125 - 250	440 - 480V							
125 - 300	550 - 600V	25,000	35,000	395 (179)	54.83 (1393)	43.25 (1099)	34.30 (871)	
125 - 150	200 - 208V	100,000	Consult Factory					
150 - 200	220 - 240V							
250 - 300	* 380 - 415V							
300 - 400	440 - 480V							
350 - 500	550 - 600V	25,000	35,000					

\* Coils Available: 380V-50Hz, 380V-60Hz, 415V-50Hz, 415V-60Hz



**NOTES:**

1. All enclosures finished in FirePump red.
2. Cable Entrance bottom only.
3. Standard Enclosure type NEMA 2.



**Electrical Wiring Schematic**

- NOTES:**  
1. PHASE FAILURE AND COMMON ALARM RELAYS ARE ENERGIZED UNDER NORMAL CONDITIONS.  
2. TRANSFORMER ONLY REQUIRED ON UNITS 380V AND UP.  
3. MAIN CONTACTS ARE SHOWN IN NO POWER CONDITION.
- LEGEND:**  
1M - START CONTACTOR  
2M - RUN CONTACTOR  
CB - CIRCUIT BREAKER  
CT - CURRENT TRANSFORMER  
MIS - MAIN ISOLATING SWITCH  
MSH - MANUAL START HANDLE (EMERGENCY)  
MTRD - MICRO SWITCH  
TRI - CONTROL TRANSFORMER

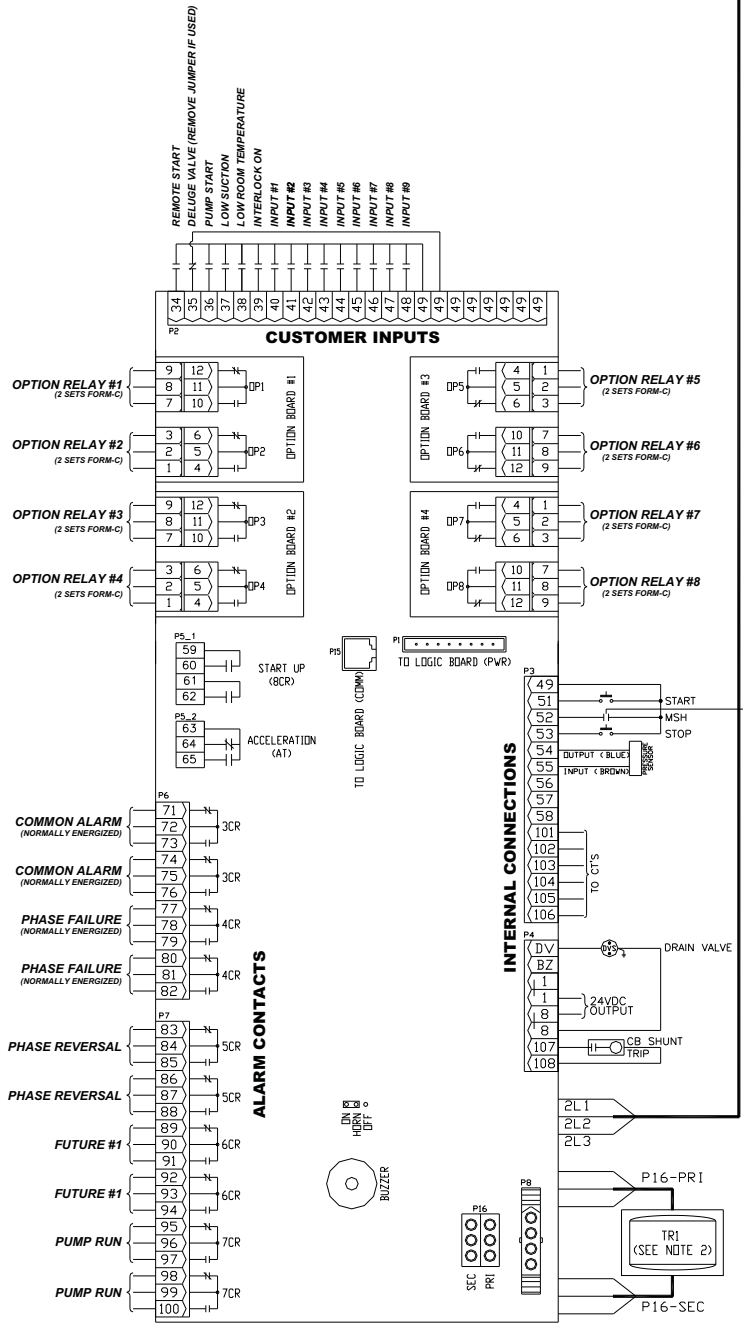
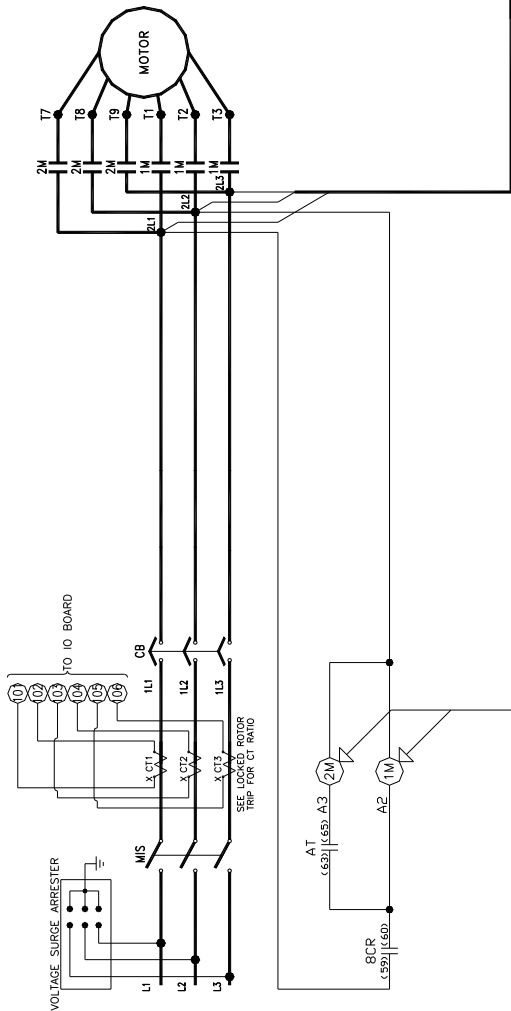



## Field Connections

### Line Terminals (Incoming Cables)

	Line Terminals on Main Isolation Switch (Incoming Cables)						Service Entrance GND. LUG Qty. & Cable Sizes
	LINE VOLTAGE					Qty. & Cable Sizes	
	200 - 208	220 - 240	*380 - 415	440 - 480	550 - 600		
Max HP	25	30	40	60	75	(1)#14-1/0 PER Ø (CU/AL)	(1)#14-2/0 (CU/AL)
	40	50	75	100	100	(1)#4-4/0 PER Ø (CU)	(1)#4-350MCM (CU/AL)
	75	75	150	200	200	(1)#3-350MCM PER Ø (CU/AL)	(1)#4-350MCM (CU/AL)
	100	125	200	250	300	(2)3/0-250MCM PER Ø (CU/AL)	(2)1/0-750MCM (CU/AL)
	150	200	350	400	400	(2)250-350MCM PER Ø (CU/AL)	(2)1/0-750MCM (CU/AL)

\* Coils available: 380V-50Hz, 380V-60Hz, 415V-50Hz, 415V-60Hz.

### Load Terminals (To Motor)

	Load Terminals (To Motor)						
	Line Voltage					Qty and Cable Sizes	
	200-208	220-240	380-415	440-480	550-600	Single Run	Double Run
Max HP	15	20	30	40	50	(1) #14 - #8 PER Ø (CU/AL)	(2) #14 - #8 PER Ø (CU/AL)
	40	50	75	100	100	(1) #14 - #1 PER Ø (CU/AL)	(2) #14 - #2 PER Ø (CU/AL)
	75	100	150	200	150	(1) #8 - 3/0 PER Ø (CU/AL)	(2) #8 - 2/0 PER Ø (CU/AL)
	150	150	250	300	300	(1) #2 - 750MCM PER Ø (CU/AL)	(2) #2 - 250MCM PER Ø (CU/AL)
	250	300	500	600	700	(1) 1/0 - 500MCM PER Ø (CU/AL)	(2) 1/0 - 500MCM PER Ø (CU/AL)

For ambient temperatures above 30C (86F), the temperature rating of motor conductors is recommended to be a minimum of 90C (194F)  
For Proper Cable Size Refer to National Electrical Code NFPA-70

### External Inputs

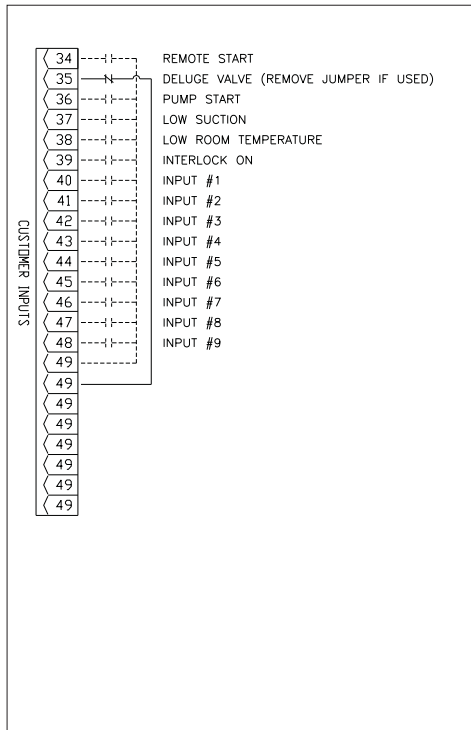

### Alarm / Relay Outputs

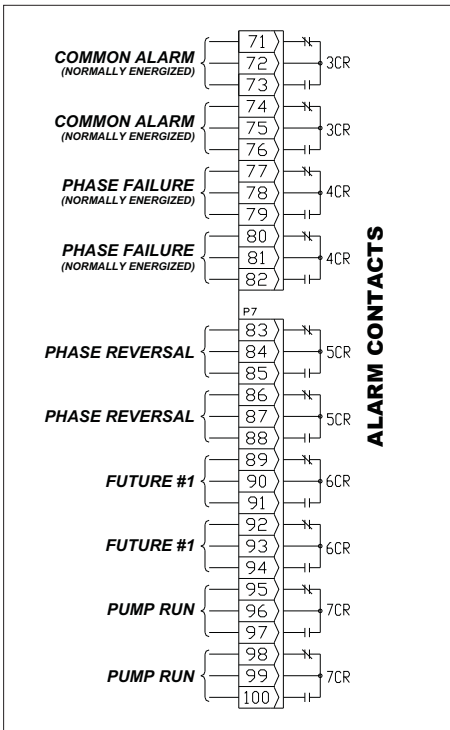

### Typical Controller Connection

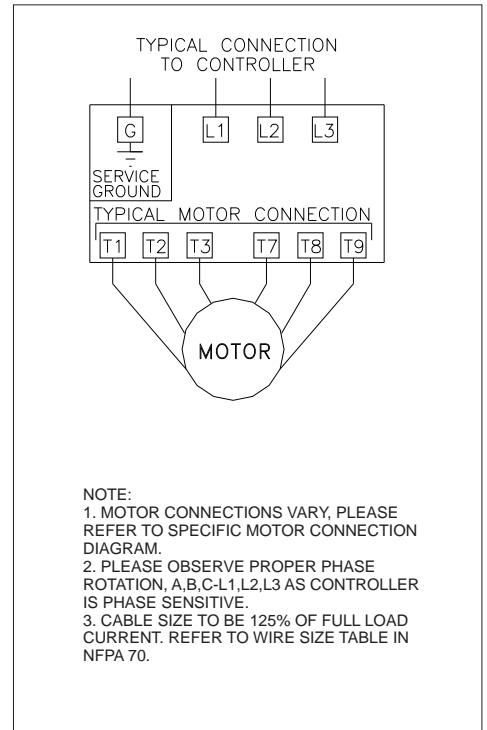

N. Y. C. APPROVED



### Part Number / Options Selection Guide

### Electric Fire Pump Controllers & Transfer Switches



## FD / FDF FT / FTF

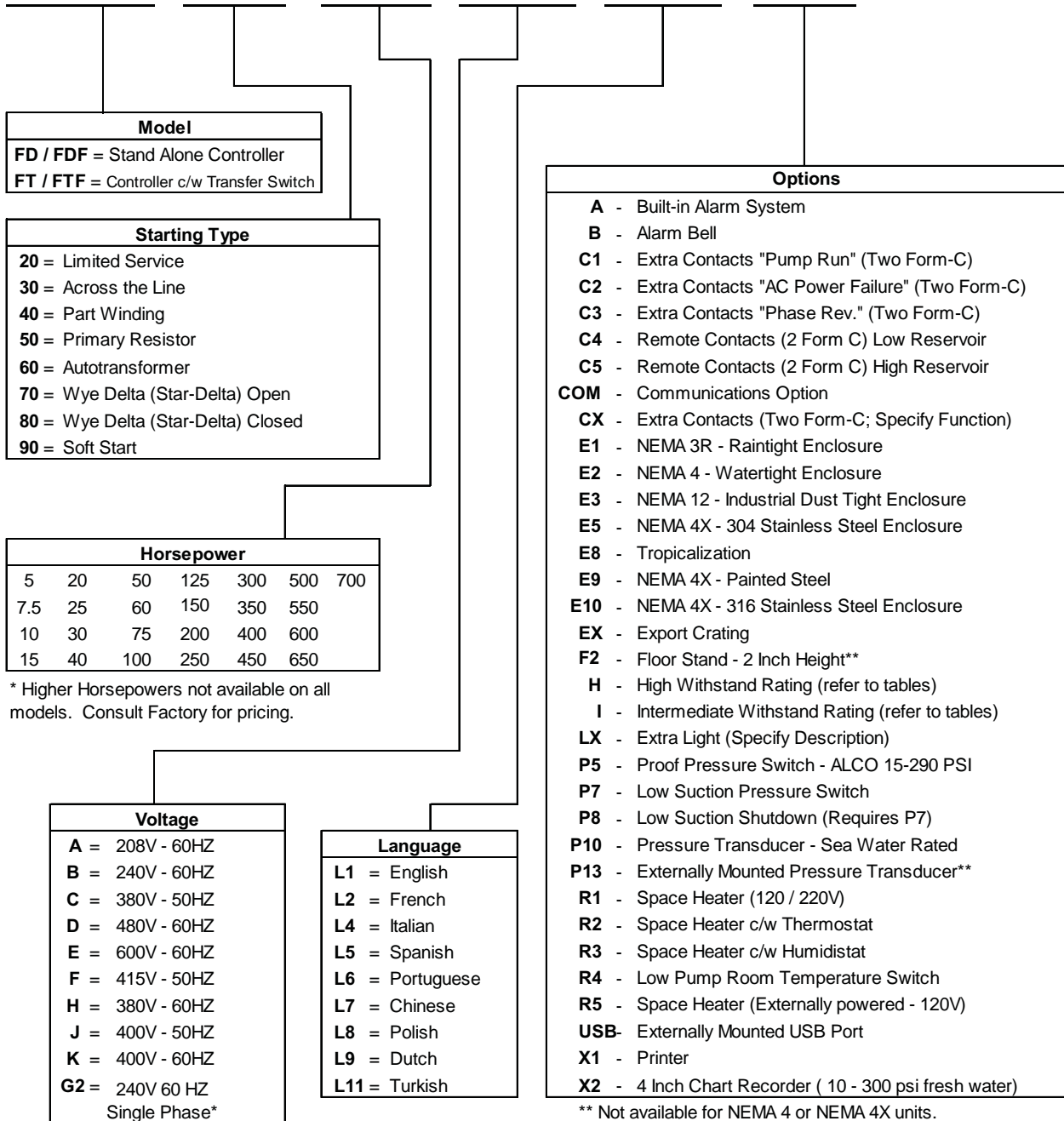

\* Only available on Limited Service Controllers



N. Y. C.  
APPROVED





## LMR Plus Electric Fire Pump Controllers

### Typical Specifications

#### 1. Approvals

- A. The Fire Pump Controller shall meet the requirements of the latest edition of NFPA 20 and shall be listed by [Underwriters Laboratories (UL)] and approved by [Factory Mutual Research (FM)] [Canadian Standards Association (CSA)] [New York Department of Buildings (NYSB)] and carry the CE marking for fire pump service.

#### 2. Starting Type

- A. The controller shall be of the combined manual and automatic type designed for [Full Voltage Starting] [Part Winding Starting] [Primary Resistor Starting] [Autotransformer Starting] [Wye-Delta (Star-Delta) Open Transition Starting] [Wye-Delta (Star-Delta) Closed Transition Starting] [Solid State Soft Start Starting]

#### 3. Ratings

- A. The Controller shall have a withstand rating of 100,000 RMS symmetrical amperes @ [208V] [240V] [380V] [400V] [415V] [480V] [25,000 @ 600VAC].

#### 4. Construction

- A. The controller shall include a motor rated combination isolating switch and circuit breaker, mechanically interlocked and operated with a single externally mounted handle.
- B. The isolating switch shall be rated to disconnect the motor load.
- C. The isolating switch/circuit breaker combination shall be mechanically interlocked such that the enclosure door cannot be opened when the handle is in the on position except by a tool operated defeater mechanism.
- D. The controller manufacturer shall manufacture the contactor, isolating switch, circuit breaker, pushbuttons, and enclosures. Brand-labeled components will not be accepted.

#### 5. Enclosure

- A. The controller shall be housed in a NEMA Type 2 (IEC IP11) drip-proof, powder baked finish, freestanding enclosure.
- B. Optional Enclosures:
  1. NEMA 3R (IEC IP14) rain-tight enclosure.
  2. NEMA 4 (IEC IP66) watertight enclosure.
  3. NEMA 4X (IEC IP66) watertight 304 stainless steel enclosure.
  4. NEMA 4X (IEC IP66) watertight 316 stainless steel enclosure.
  5. NEMA 4X (IEC IP66) watertight corrosion resistant enclosure.
  6. NEMA 12 (IEC IP52) dust-tight enclosure.

#### 6. Microprocessor Control

- A. The controller shall come complete with a 4 line by 40 character LCD display mounted on a panel opening in the front door. The LCD display shall indicate the following:
  1. Main screen displaying system pressure, three-phase voltage and amperage readings, system frequency, date, and time.
  2. Set point review screen displaying the programmed pressure start and stop points, and weekly test time.
  3. Controller statistics screen, including:
    - a. Powered Time
    - b. Motor Run Time
    - c. Number of Calls to Start
    - d. Number of Starts
    - e. Last Motor Start Time
    - f. Last Motor Run Time
    - g. Last Low Pressure Start
    - h. Minimum System Voltage
    - i. Maximum System Voltage
    - j. Minimum System Frequency
    - k. Maximum System Frequency
    - l. Minimum System Pressure
    - m. Maximum System Pressure
    - n. Last System Startup
    - o. Last Phase Failure
    - p. Last Phase Reversal
    - q. Last Locked Rotor Trip
    - r. Maximum Run Current
    - s. Last Locked Rotor Current
  4. Controller diagnostics screen, including:
    - a. Date & Time
    - b. Firmware Version
    - c. Shop Order Number
    - d. Customer Order Number
    - e. Transformer Output Voltage
    - f. Current Transformer Outputs
    - g. Pressure Transducer Calibrated Settings
    - h. Input Status
    - i. Output Status
  5. Display last messages screen that will display up to 10,000 alarms/messages stored in the controllers' memory.
  6. Display up to ten (10) custom messages of up to 100 characters each, which will continually scroll across the fourth line of the display.
  7. Remaining time left on active timers.
- B. The controller shall be supplied with ten (10) green status LED's for the following:
  1. Power On
  2. Pump Running
  3. Local Start
  4. Remote Start
  5. Deluge Valve
  6. Emergency Start

## LMR Plus Electric Fire Pump Controllers

7. Interlock On
  8. Low Pressure
  9. Auto Shutdown Enabled
  10. Programmable LED #1
  - C. The controller shall be supplied with ten (10) red alarm LED's to indicate the following:
    1. Phase Reversal
    2. Phase Failure
    3. Fail to Start
    4. Undervoltage
    5. Overvoltage
    6. Low Room Temperature
    7. Locked Rotor Trip
    8. Low Suction Pressure
    9. Source 2 Disconnected
    10. Programmable LED #2
  - D. The microprocessor logic board shall be available with:
    1. A USB port for transference of message history, controller status, diagnostics, and statistics and the ability to update firmware.
    2. An optional Ethernet port for direct connection to a computer for data transfer.
    3. An optional RS485 Serial port for communication to various external software programs.
  - E. The controller shall be available with an embedded web page to allow viewing of the controllers' current status, data values, programmed set points, and history.
  - F. A Fail-to-Start alarm shall occur if the motor controller sees less than 20% of the motor full load amps after an adjustable time delay of 1-90 seconds.
  - G. Locked rotor protection shall be provided. After a trip condition and restoration of power, the LCD display shall indicate "LOCKED ROTOR TRIP".
  - H. A sequential start timer and weekly test timer shall be provided as standard.
  - I. A restart time delay of two (2) seconds shall be provided to allow the residual voltage of the motor to decay prior to re-starting the motor. In the event that the pump motor continues to run after a request to stop, then the controller must display a fail to stop message to indicate this condition.
  - J. Overvoltage (5-20%) and undervoltage (5-30%) sensing and alarming shall be provided as standard.
  - K. The controller shall be supplied with interlock and shutdown circuits as standard. A flashing green LED shall indicate an interlock on condition.
  - L. Where shutdown of the pump(s) due to low suction pressure is required, it shall be accomplished without the addition of a separate panel or enclosure. The LCD display shall indicate low suction shutdown. Resetting of the condition shall be automatic or manual as selected by the user.
  - M. Means shall be provided to test the operation of all LED's to ensure their functionality.
7. **Programming Menu**
    - A. The programming menu shall have the ability to enable an entry password.
    - B. The programming menu shall be limited to two (2) levels of password protection.
    - C. The controller shall have three (3) languages as a standard, English, French, and Spanish, with the ability to add a fourth language.
    - D. The programming menu shall be grouped into 6 main menu headings as follows:
      1. Regional Settings
      2. Pressure Settings
      3. Timer Values
      4. Alarm Set points
      5. Input/Output Menu
      6. System Configuration (password protected)
  8. **Pressure Sensor**
    - A. A solid-state 4-20mA pressure sensor shall be provided. The pressure Start and Stop points shall be adjustable in increments of one (1) PSI. A low pressure pre-alarm, indicated with a flashing green LED, shall denote a potential pump starting condition and will remain lit once the pump has started to indicate the starting cause.
  9. **Custom Inputs/Outputs**
    - A. The controller shall come standard with nine (9) future inputs, two (2) future LED indicators, and one (1) future output, with the ability to add up to another 8 outputs via optional relay boards.
    - B. The user shall be able to program the future inputs/outputs through the main programming menu.
    - C. The inputs shall be selectable based on the following criteria:
      1. User selected message or thirteen (13) predetermined messages.
      2. Energize the common alarm relay when the input is received.
      3. Link to a future relay and/or LED indicator.
      4. Alarm latched until reset.
      5. Normally open or closed input.
      6. On-delay timer.
    - D. The LED indicators shall be selectable based on the following criteria:
      1. Indication based on a minimum of twelve (12) predetermined alarms or a custom input.
    - E. The future relays shall be selectable based on the following criteria:
      1. Output based on a minimum of twenty-seven (27) predetermined alarms, controller status or a custom input.
      2. Latched until reset.
      3. Energized under normal conditions.
      4. On or off delay timer on the output.

---

## **LMR Plus Electric Fire Pump Controllers**

---

### **10. Alarm Relays**

- A. All relays shall be of the plug-in type. An LED on the relay panel shall indicate the energized state of the relay. All relay contacts shall be rated @ 8A, 277VAC/30VDC. Two (2) sets of Form-C contacts shall be provided for each of the following:
  - 1. Phase Reversal
  - 2. Phase Failure
  - 3. Common Alarm
  - 4. Future #1
  - 5. Pump Run.
- B. The Common Alarm and Phase Failure relays shall be energized under normal conditions.

### **11. Audible Alarm Buzzer**

An audible alarm buzzer, capable of being heard while the motor is operating, shall operate if Fail to Start, Hardware Malfunction or any Common Alarm condition exists.

### **12. Manufacturer**

- A. The controller shall be of the LMR Plus type as manufactured by Eaton Corporation.